



IPC

Spare parts list

Ref: IDAF40359

Model: H.P. CLEANER BENZ-C L DL2021Pi P IPC

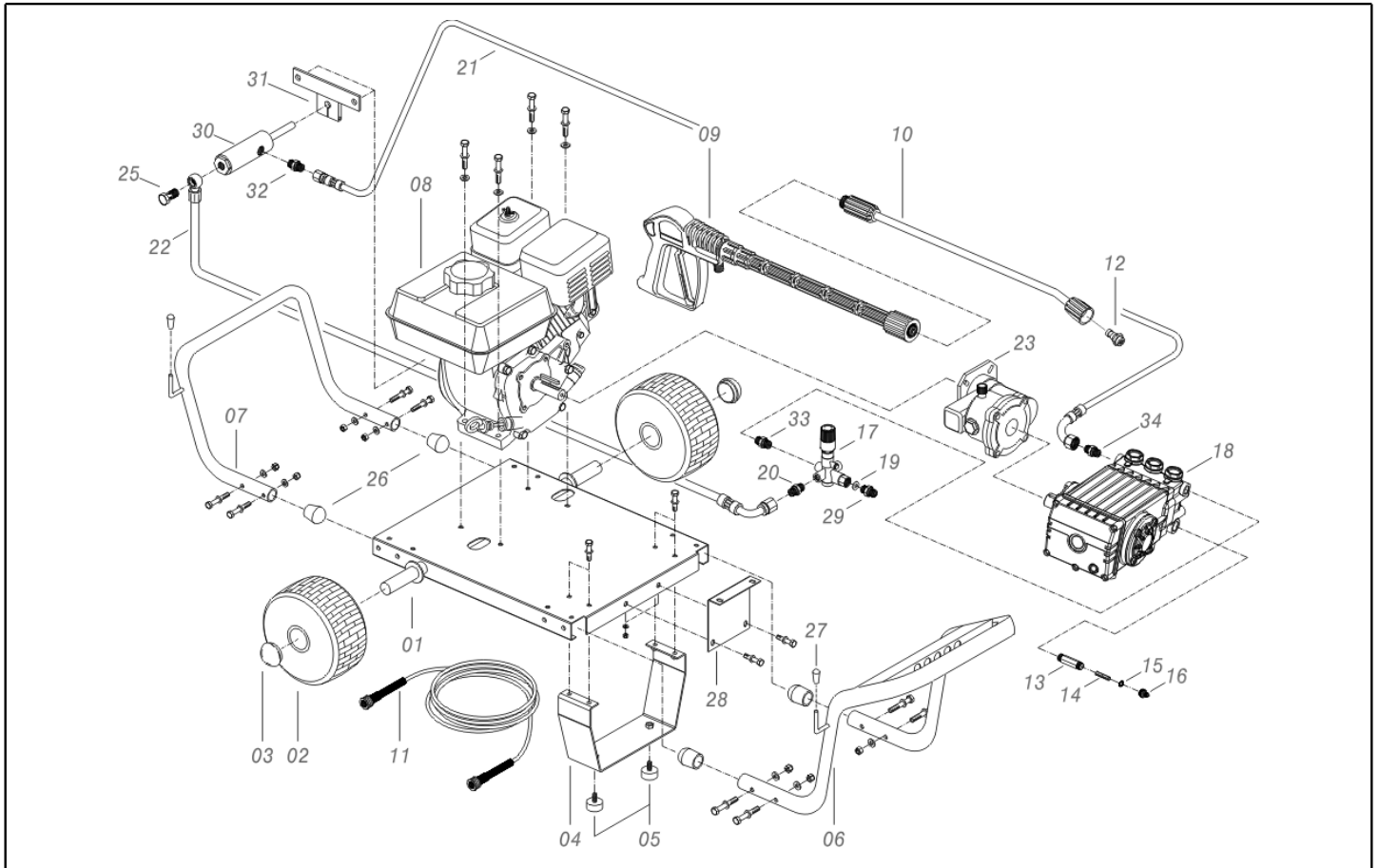

Ref. K	Part n.	Customer part n.	Description	Quantity	Validity		Price
					From	To	
0001	LAFN40179		CHASSIS BENZ HP 9-13	1,00			--
0002	RTRT40006		WHEEL D. 13.5"X 6/6 -D.25 PN.	2,00			--
0003	VTVR01268	00001268	HUB CAP D. 25	2,00			--
0004	LAFN40181		FOOT BENZ HP 9-13	1,00			--
0005	MPVR60726	00060726	VIBRATION DAMP. TCC48X25- 1M8X16 60SH GMM	2,00			--
0006	LAFN40188		HANDLE BENZ HP 9-13	1,00			--
0007	LAFN40183		BUMPER BENZ HP 9-13	1,00			--
0008	MOSC40002		ENGINE MOTOR HONDA GX390 UT2 QX Q4 OH	1,00	01/10/2011		--
0008	MOSC71925	00071925	ENGINE MOTOR HONDA GX390 QX 13HP AV.MA	1,00		30/09/2011	--
0009	IPPR40010		GRIP G 5100+P.330 +M22 SV.M V	1,00	16/04/2014		--
0009	IPPR89429		GRIP G 4500 - P.330 -M22SV.M V	1,00		15/04/2014	--
0010	LCPR40013		EXTENSION P 70 - HYPERJET 1/4F	1,00			--
0011	TBAP25324	00025324	H.P. HOSE R1 MT 10 5/16" C/2 IRV ZC	1,00			--
0012	UGLN49995	00049995	NOZZLE LECH 1/4 25065	1,00			--
0013	RCDS46109	00046109	NIPPLE 3/4 - 1/2 RYL INX	1,00			--
0014	FTAC30214	00030214	FILTER D.15X67	1,00			--
0016	RCVR29600	00029600	SOCKET PTC 3/4 F	1,00			--
0017	VVAZ40004		VALVE BP 93 C/M.310B. 3/8-1/4F	1,00			--
0018	PPAP42822	00042822	PUMP WS132 DX LT 18-120 B. USA	1,00			--
0019	VTRS00548	00000548	WASHER D.17,5X23X1,5 (3/8)RM	1,00			--
0020	RCDS00607	00000607	NIPPLE 1/4 - 1/4 SV	1,00			--
0021	TBAP40031		POLYAMIDE HOSE 1/4 L=430 1/4F -1/4F 90°	1,00			--
0022	TBAP40032		POLYAMIDE HOSE 1/4 L=580 1/4OC -1/4F 90°	1,00			--
0023	RDGR40000		REDUCTION UNIT PA B18H HP 11-18	1,00		25/10/2010	--
0023	RDGR40001		REDUCTION UNIT RS 500H	1,00	26/10/2010		--
0025	RCDS02612	00002612	SCREW G 1/4 A.P.	1,00			--
0026	MPVR01697	00001697	PROD D.30 1.02.109	4,00			--
0027	MPVR32471	00032471	PROD D. 8 BK	2,00			--
0028	LAFN40193		SUPPORT BRACKET BENZ HP 13.0 LS	1,00			--
0029	RCIN09348	00009348	MALE COUPLING 3/8MA L=32	1,00			--
0030	KTRI10685	00010685	KIT P 14- 53	1,00	15/04/2009		--
0031	LAFN11807	00011807	BRACKET SF/HONDA	1,00			--
0033	RCDS12121	00012121	NIPPLE 3/8 - 3/8 SV/CN	1,00			--
0034	RCDS00609	00000609	NIPPLE 1/2 - 1/4 SV	1,00			--

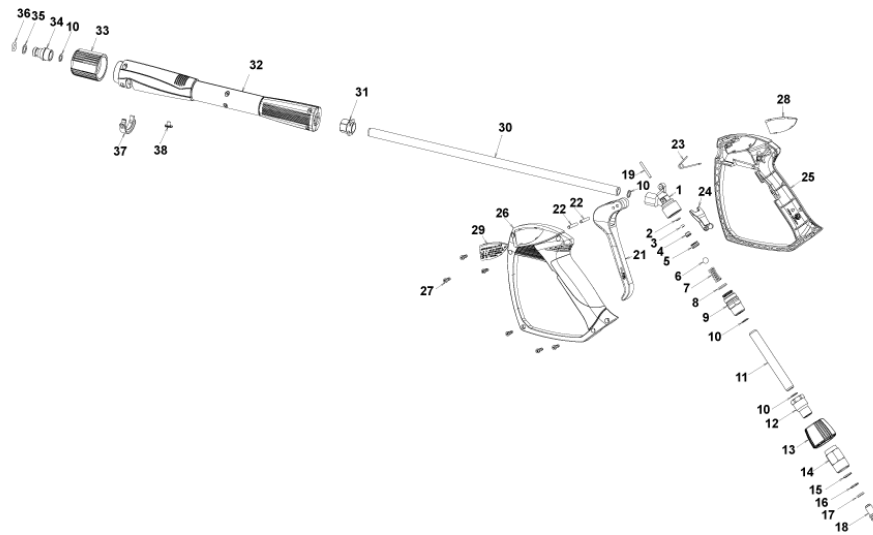

Ref. K	Part n.	Customer part n.	Description	Quantity	Validity		Price
					From	To	
0001	PVVR40381		GUN BODY G 5100 G1/4F	1,00			--
0002	S GUVR40074		ANTI-EXTR.RING D. 3 X 7.4X1.3	1,00			--
0003	S GUGO21835	00021835	O-RING D. 2.84 X 2.62 VIT. 80SH	1,00			--
0004	PVVR40382		PISTON GUIDE G 5100	1,00			--
0005	S PVVR40112		BALL SEAT G 5000	1,00			--
0006	S SFVR27026	00027026	BALL D.11/32" INX	1,00			--
0007	MLML40016		SPRING D. 9.4 x21.5x1.6 G5000	1,00			--
0008	GUGO12322	00012322	O-RING D. 14 X 1.78 NBR 90SH	1,00			--
0009	PVVR40383		CONNECTOR COLL.G5100 1/4F	1,00			--
0010	VTRS40017		WASHER D. 8.2X11,4X1.00	4,00			--
0011	PVVR40384		TUBE G 1/4" L.105	1,00			--
0012	RCIN40022		CONNECTOR SWIV G5100 1/4F	1,00			--
0013	MPVR40486		RING NUT G 5100 SW. GR.	1,00			--
0014	RCIN40021		JOINT SWIV 5100 M22	1,00			--
0015	S GUVR40075		ANTI-EXTR.RING D. 10 X14X1.5	1,00			--
0016	S GUVR40076		ANTI-EXTR.RING D. 11.2X14X1.2	1,00			--
0017	S GUGO15295	00015295	O-RING D. 10.82 X 1.78 VIT 75SH	1,00			--
0018	PVVR40386		SCREW SW. G 5100	1,00			--
0019	PVVR40387		SMALL PISTON G 5100	1,00			--
0021	MPVR40487		TRIGGER G 5100-SW	1,00			--
0022	VTVR40047		PLUG D. 4X29	2,00			--
0023	MLML40029		SPRING G 5100	1,00			--
0024	MPVR40488		SAFETY-DEVICE G 5100-SW	1,00			--
0025	MPVR40489		SHELL G 5100-SW DX	1,00			--
0026	MPVR40490		SHELL G 5100-SW SX	1,00			--
0027	VTVT40043		SCREW AF 4X 14 HILO ZN.N	6,00			--
0028	MPVR40491		PLATE G 5100 GR.DX	1,00			--
0029	MPVR40492		PLATE G 5100 GR.SX	1,00			--
0030	LCPR40086		TUBE 1/4 L=420 ZC. 0°	1,00			--
0031	MPVR40493		CONNECTOR G 5100-SW	1,00			--
0032	MPVR40494		PROTECTION P 420 C/AN.	1,00			--
0033	PVVR40119		CONNECTION M22X1.5 IRV G5000	1,00			--
0034	RCIN40009		GUDGEON G 1/4 F IRV G5000	1,00			--
0035	GUVR40034		ANTI-EXTR.RING D. 10 X14	1,00			--
0036	GUGO01946	00001946	O-RING D. 9.13 X 2.62 VIT 70SH	1,00			--
0037	MPVR40495		CAP G 5100 REM.	1,00			--
0038	MPVR40198		CAP G 5000	1,00			--

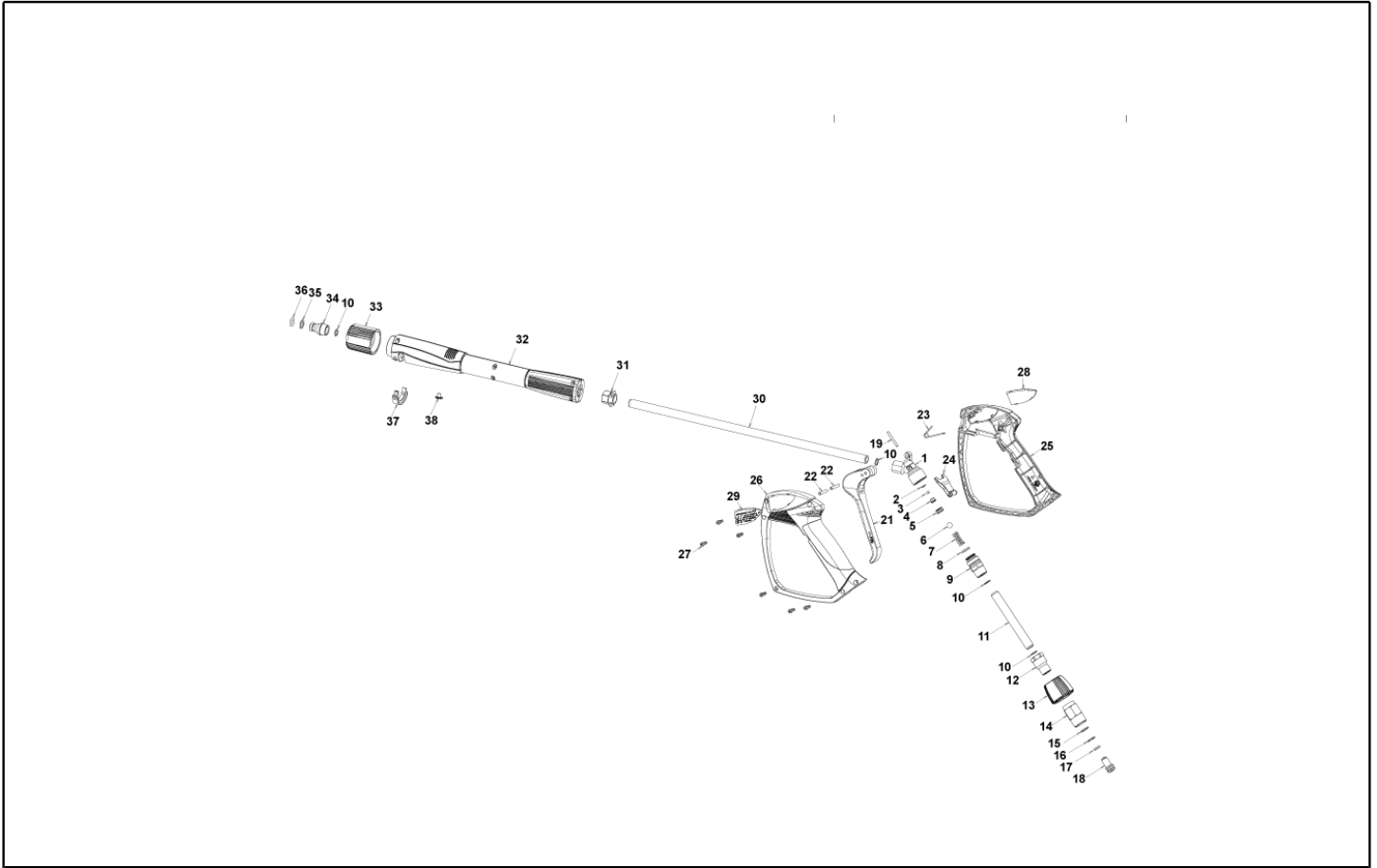

Ref. Part n.	Cust. part n.	Description	Reference	Price
KTRI40242		KIT P 26- 25 G 5100	0002 0003 0005 0006	--
KTRI40243		KIT P 26- 26 SWIVEL G 5100	0015 0016 0017	--

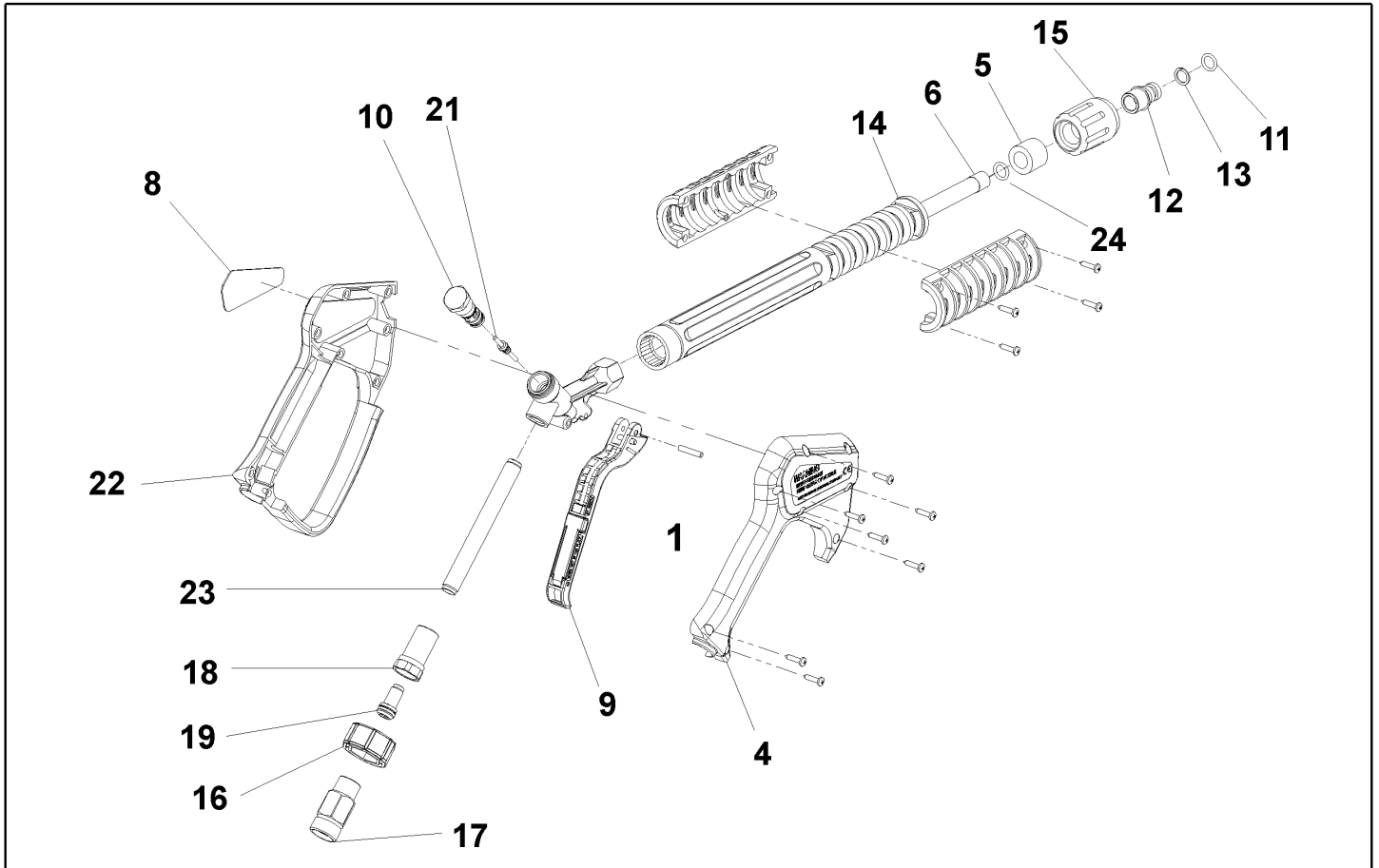

Ref. K	Part n.	Customer part n.	Description	Quantity	Validity		Price
					From	To	
0001	VTVR46568	00046568	PLUG G 4500	1,00			--
0004	MPVR46563	00046563	COVER G 4500	1,00		30/04/2008	--
0004	MPVR40157		COVER G 4500 2V.	1,00	01/05/2008		--
0005	MPVR46572	00046572	SPACER P 330 ST	1,00			--
0006	LCPR46571	00046571	TUBE 1/4 L=352 ZC.	1,00		30/04/2008	--
0006	LCPR40007		TUBE 1/4 L=352 ZC. 2V.	1,00	01/05/2008		--
0008	MPVR46569	00046569	PLATE G 4500 RD.	1,00			--
0009	MPVR40057		TRIGGER G 4500 -SW	1,00			--
0010	PVVR40030		SMALL PISTON TM ST-2300	1,00			--
0011	GUGO10384	00010384	O-RING D. 10 X 2.2 VIT 80SH	1,00			--
0012	RCVR13030	00013030	GUDGEON G 1/4 F L=31.5	1,00			--
0013	GUVR10526	00010526	ANTI-EXTR.RING D.13.9X10.2 C.BZ	1,00			--
0014	MPVR46570	00046570	PROTECTION P 330 ST	1,00			--
0015	PVVR13445	00013445	CONNECTION M 22X1,5 L=45	1,00			--
0016	MPVR40058		RING NUT G4500 SW.	1,00			--
0017	RCIN40001		JOINT SWIV 4500 3/8"F	1,00		30/04/2008	--
0017	RCIN40005		JOINT SWIV 4500 3/8"F 2V.	1,00	01/05/2008		--
0018	RCIN31641	00031641	CONNECTOR SWIV 1500 F	1,00			--
0019	KTRI31645	00031645	KIT P 26- 14	1,00			--
0021	PVVR40031		ROD ST-2300	1,00			--
0022	MPVR46562	00046562	SHELL G 4500	1,00		30/04/2008	--
0022	MPVR40156		SHELL G 4500 2V.	1,00	01/05/2008		--
0023	PVVR40023		TUBE G 1/4" M/M P/SW.	1,00			--
0024	GUGO27021	00027021	O-RING D. 11 X 2.5 EPD 70SH	1,00	01/05/2008		--

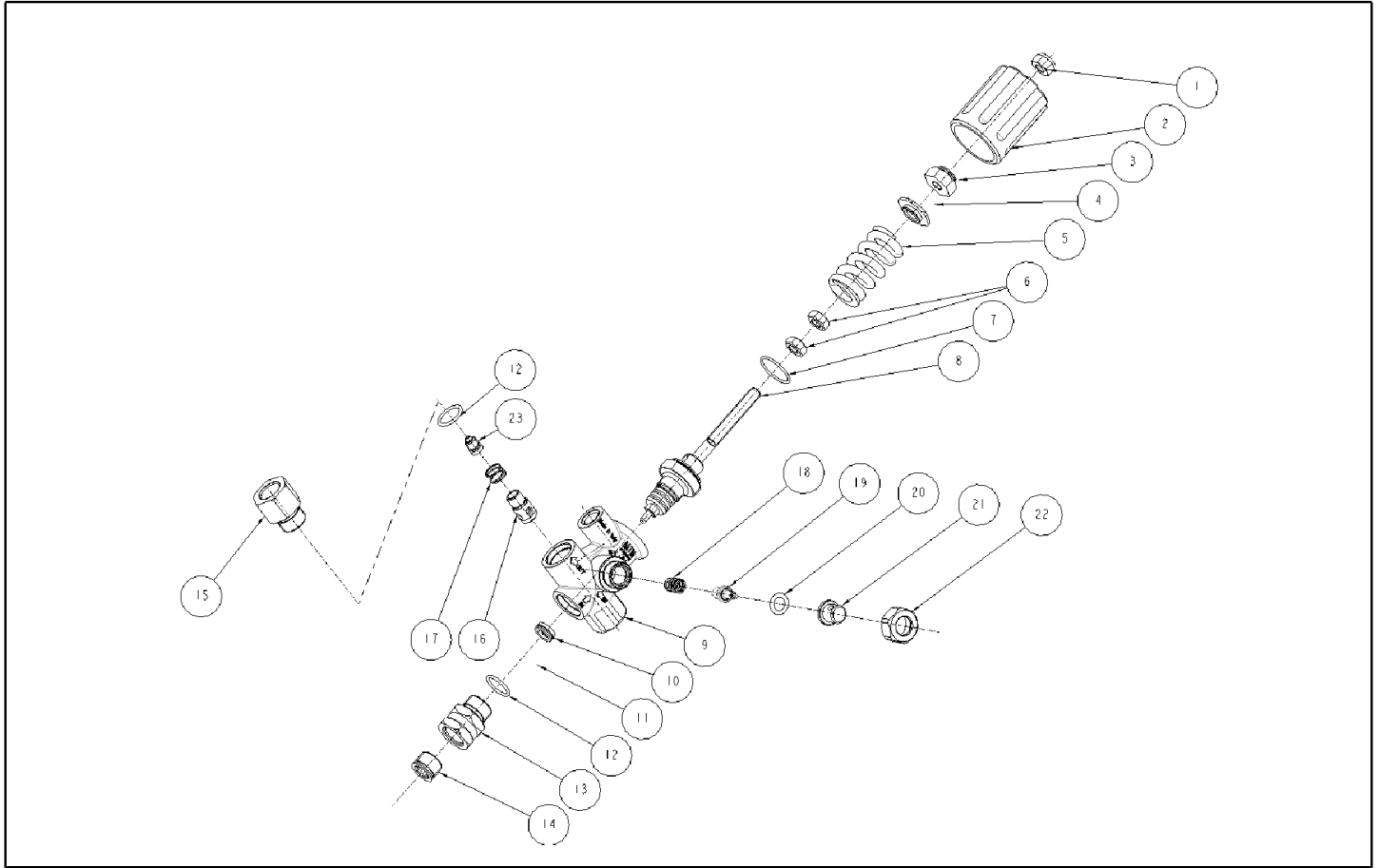

Ref. K	Part n.	Customer part n.	Description	Quantity	Validity		Price
					From	To	
0001	VTDD89669		NUT M 8 X1 AUT. INX A2	1,00			--
0002	MPVR40002		KNOB BP9 BK.	1,00			--
0003	VTDD88134	00088134	NUT M 8 BY-PASS BP91	1,00			--
0004	PVVR88140	00088140	SPRING PLATE BP91	1,00			--
0005	MLML40014		SPRING D.15.6 X27 L=51.5 310B.	1,00			--
0006	VTDD40000		NUT M 8 X1 UNI5588 INX A2	2,00			--
0007	GUGO11652	00011652	O-RING D. 12.42 X 1.78 NBR 70SH	1,00			--
0008	PVVR40016		PUSH ROD BP9 CP.	1,00			--
0009	PVVR40107		VALVE BODY BP 93 3/8"	1,00			--
0010	PVVR88135	00088135	INSERT BY-PASS BP91	1,00			--
0011	SFVR88141	00088141	BALL D.17/32" AISI 440	1,00			--
0012	GUGO03505	00003505	O-RING D. 15.6 X 1.78 NBR 70SH	2,00			--
0013	PVVR88138	00088138	CONNECTOR EASY-ST. BP91	1,00			--
0014	PVVR88139	00088139	CAP 3/8 M BP91	1,00			--
0015	PVVR49638	00049638	CONNECTOR BP91 3/8F	1,00			--
0016	PVVR49636	00049636	SMALL PISTON BP91 C/OR	1,00			--
0017	MLML49637	00049637	SPRING BP91	1,00			--
0018	MLML40015		SPRING D. 9,2X18,26X1 BP 93	1,00			--
0019	PVVR40108		ELEMENT TH. BP 93	1,00			--
0020	GUGO28927	00028927	O-RING D. 9.13 X 2.62 NBR 70SH	1,00			--
0021	PVVR40109		CONNECTOR BP 93	1,00			--
0022	PVVR40110		RING NUT M18X1 BP 93	1,00			--

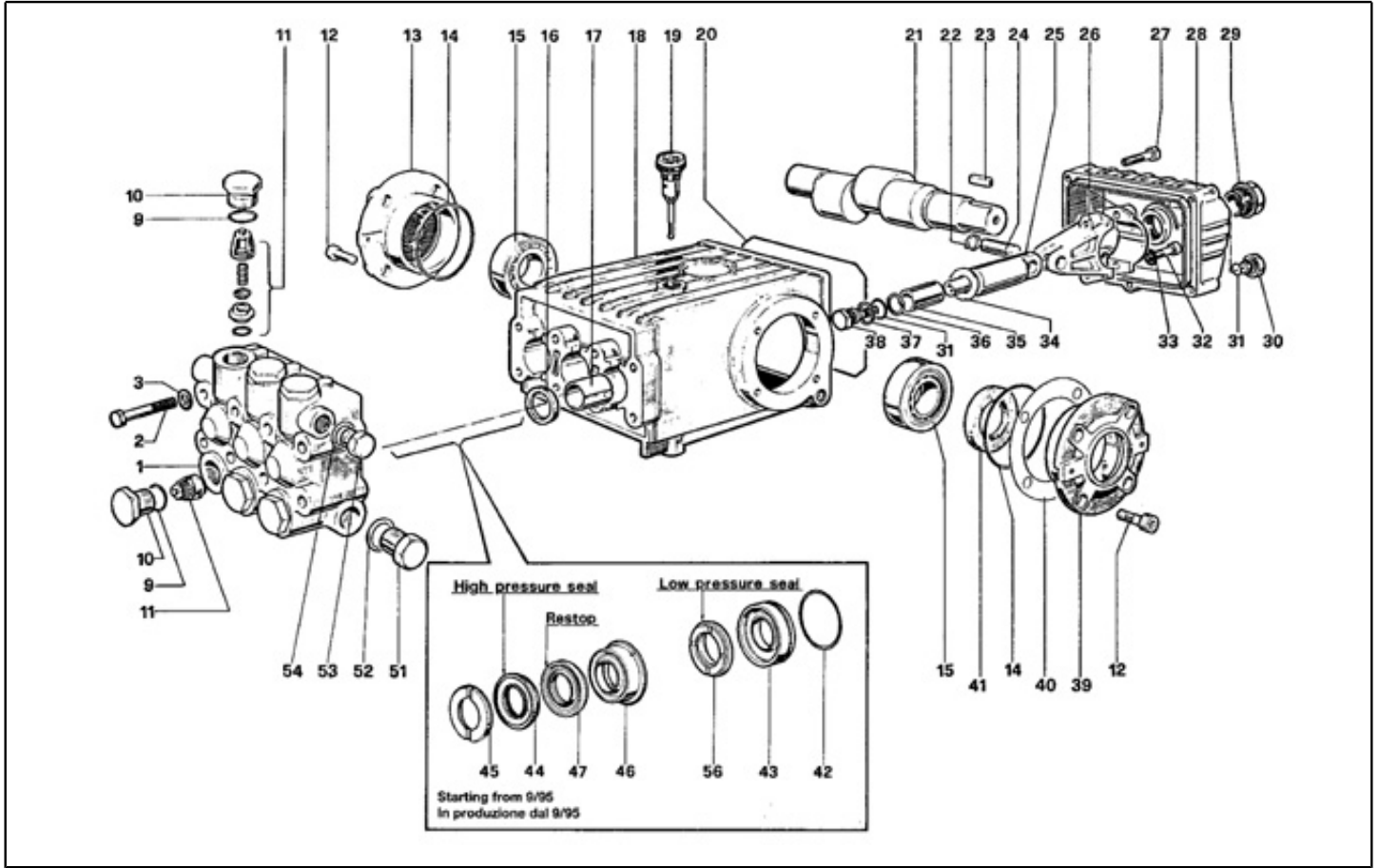

Ref. K	Part n.	Customer part n.	Description	Quantity	Validity		Price
					From	To	
0001	MFVR01097	00001097	HEAD W 151	1,00			--
0002	VTVT01111	00001111	SCREW TE M 8X70 UNI 5737 A.10.9	8,00			--
0003	VTRS01072	00001072	WASHER D. 8 TC	8,00			--
0009	S GUGO01033	00001033	O-RING D. 20.24 X 2.62 NBR 90SH	6,00			--
0010	S RCDS01087	00001087	CAP M24X2X16 OTT	6,00			--
0011	S VVAM01104	00001104	VALVE UNIT W 70-151	6,00			--
0012	VTVT01118	00001118	SCREW TCEI M 8X16 ZC. UNI 5931	8,00			--
0013	MFVR03576	00003576	CRANKASE COVER W151	1,00			--
0014	GUGO01041	00001041	O-RING D. 67.95 X 2.62 NBR 70SH	2,00			--
0015	CUVR09205	00009205	ROLLER BEARING 32206 A	2,00			--
0016	S GUGO01000	00001000	OIL SEAL 22X 32X 5 NBR70	3,00			--
0017	PVVR01011	00001011	BUSHING W 151	3,00			--
0018	MFVR01013	00001013	PUMP CRANKCASE W 151	1,00			--
0019	PVVR01092	00001092	OIL DIPSTICK W 151	1,00			--
0020	GUGO34590	00034590	O-RING D. 133.02 X 2.62 NBR 70SH	1,00			--
0021	ALMO41530	00041530	SHAFT TS 1511 USA	1,00			--
0022	VTAE14016	00014016	CIRCLIP D. 12 UNI 7435	6,00			--
0023	VTVR41531	00041531	KEY 8X 7X35 UNI 6604A	1,00			--
0024	PVVR01085	00001085	GUDGEON D.13X35 W151	3,00			--
0025	PVVR01029	00001029	PISTON GUIDE W 151	3,00			--
0026	BLVR01009	00001009	CONNECTING ROD W 151	3,00			--
0027	VTVT01116	00001116	SCREW TCEI 6X30 UNI5931	5,00			--
0028	MFVR03582	00003582	CRANKASE COVER W 151 POS	1,00			--
0029	PVVR01083	00001083	OIL INDICATOR G 3/4 W70-151	1,00			--
0030	RCDS01088	00001088	CAP 1/4X 9 M WW90	1,00			--
0031	S GUGO01036	00001036	O-RING D. 10.82 X 1.78 NBR 70SH	4,00			--
0032	VTVT01120	00001120	SCREW TCEI 8X35 UNI5931	6,00			--
0033	VTRS14242	00014242	WASHER D. 8.4X13X0.8 UNI7064 SCH	6,00			--
0034	S VTRS01753	00001753	WASHER D.14X28 X0,5	3,00			--
0035	PIVR01067	00001067	PISTON D.22X50 W 132	3,00			--
0036	S GUVR00994	00000994	ANTI-EXTR.RING W151	3,00			--
0037	S VTRS01076	00001076	WASHER D.14X18,5X0,5	3,00			--
0038	S PVVR01107	00001107	PISTON BOLT IP W151	3,00			--
0039	MFVR03583	00003583	CRANKASE COVER W151	1,00			--
0040	PVVR01016	00001016	THICKNESS 0,1 W 151	2,00			--
0041	S GUGO01003	00001003	OIL SEAL 30X 55X 7 NBR70	1,00			--
0042	S GUGO01042	00001042	O-RING D. 34.6 X 1.78 NBR 70SH	3,00			--
0043	S PVVR00978	00000978	PACKING RETAIN. W132	3,00			--
0044	S GUVR00982	00000982	PACKING W132	3,00			--
0045	S PVVR00986	00000986	HEAD RING W132	3,00			--
0046	S PVVR34588	00034588	INTERMED. RING W 132 D. 22	3,00			--
0047	S GUVR34586	00034586	PACKING D. 22 RESTOP	3,00			--
0051	RCDS01091	00001091	CAP 1/2X10 M	1,00			--
0052	VTRS01075	00001075	WASHER D.21,5X27 ALL	1,00			--

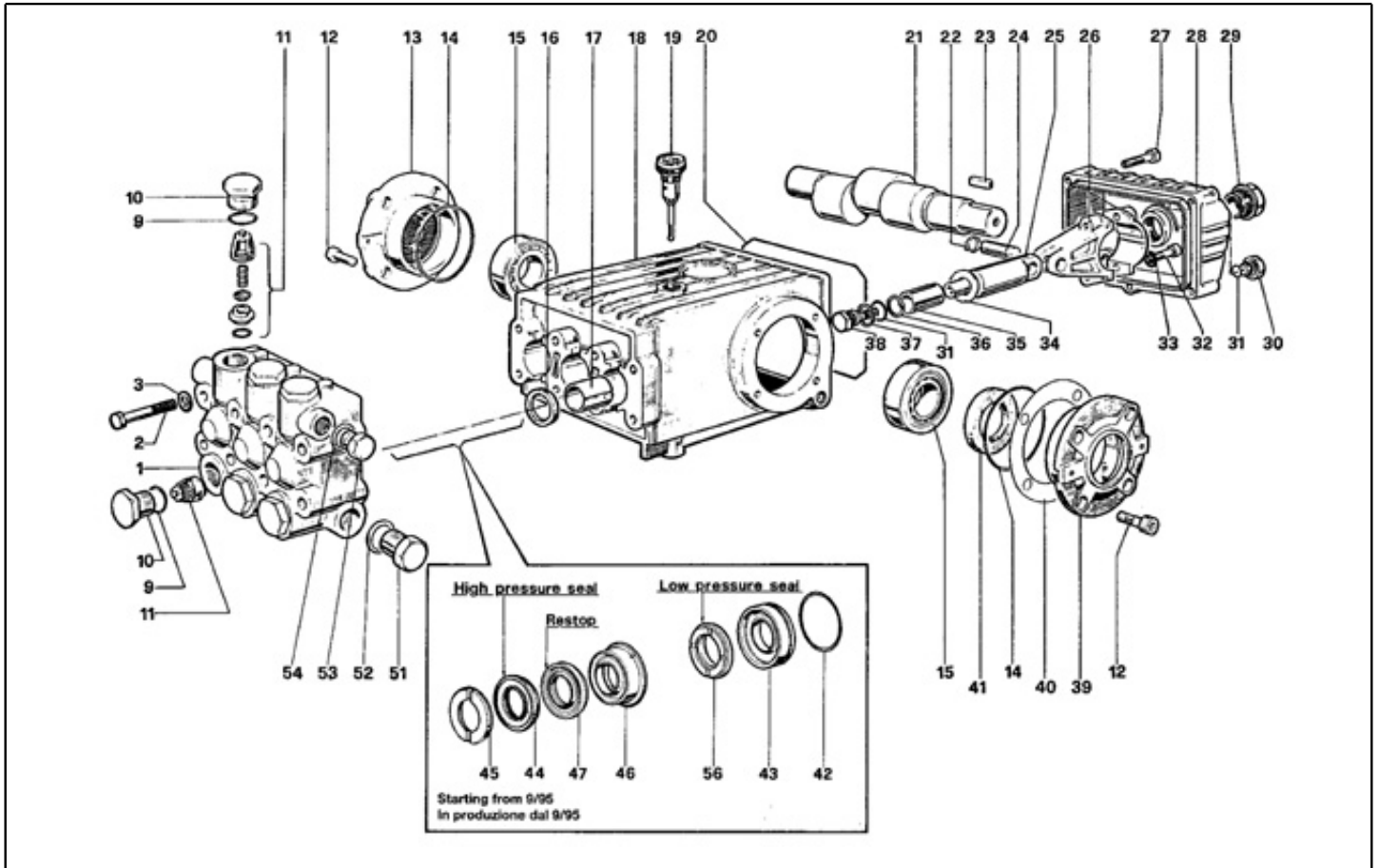

Ref. K	Part n.	Customer part n.	Description	Quantity	Validity		Price
					From	To	
0053	RCDS01090	00001090	CAP 3/8X13 M WW90	1,00			--
0054	VTRS01074	00001074	WASHER D.17,05X22,3 X1,5	1,00			--
0056	S GUVR34584	00034584	PACKING W 132 L.P.	3,00			--

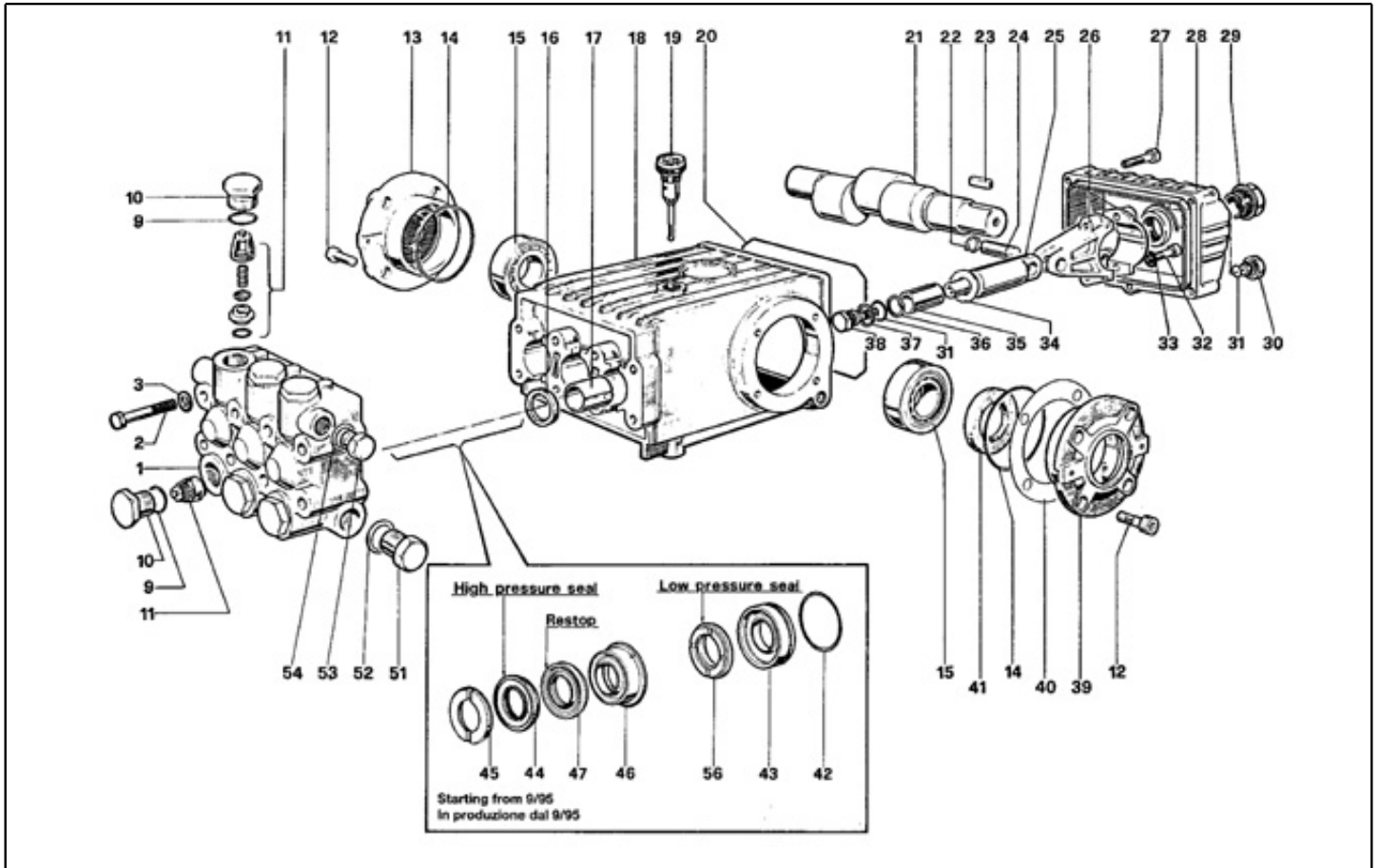

Ref. Part n.	Cust. part n.	Description	Reference	Price
KTRI17795		KIT P 4	0009 0010	--
KTRI17859		KIT P 1	0011	--
KTRI17860		KIT P 15- 2	0016	--
KTRI17793		KIT P 6	0031 0034 0036 0037 0038	--
KTRI14900		KIT P 15- 3	0041	--
KTRI17878		KIT P 14	0042 0043	--
KTRI18590		KIT P 29	0042 0043 0044 0045 0046 0047 0056	--
KTRI18588		KIT P 11	0045	--
KTRI36166		KIT P 148	0044 0047 0056	--
KTRI36133		KIT P 149	0046 0047	--

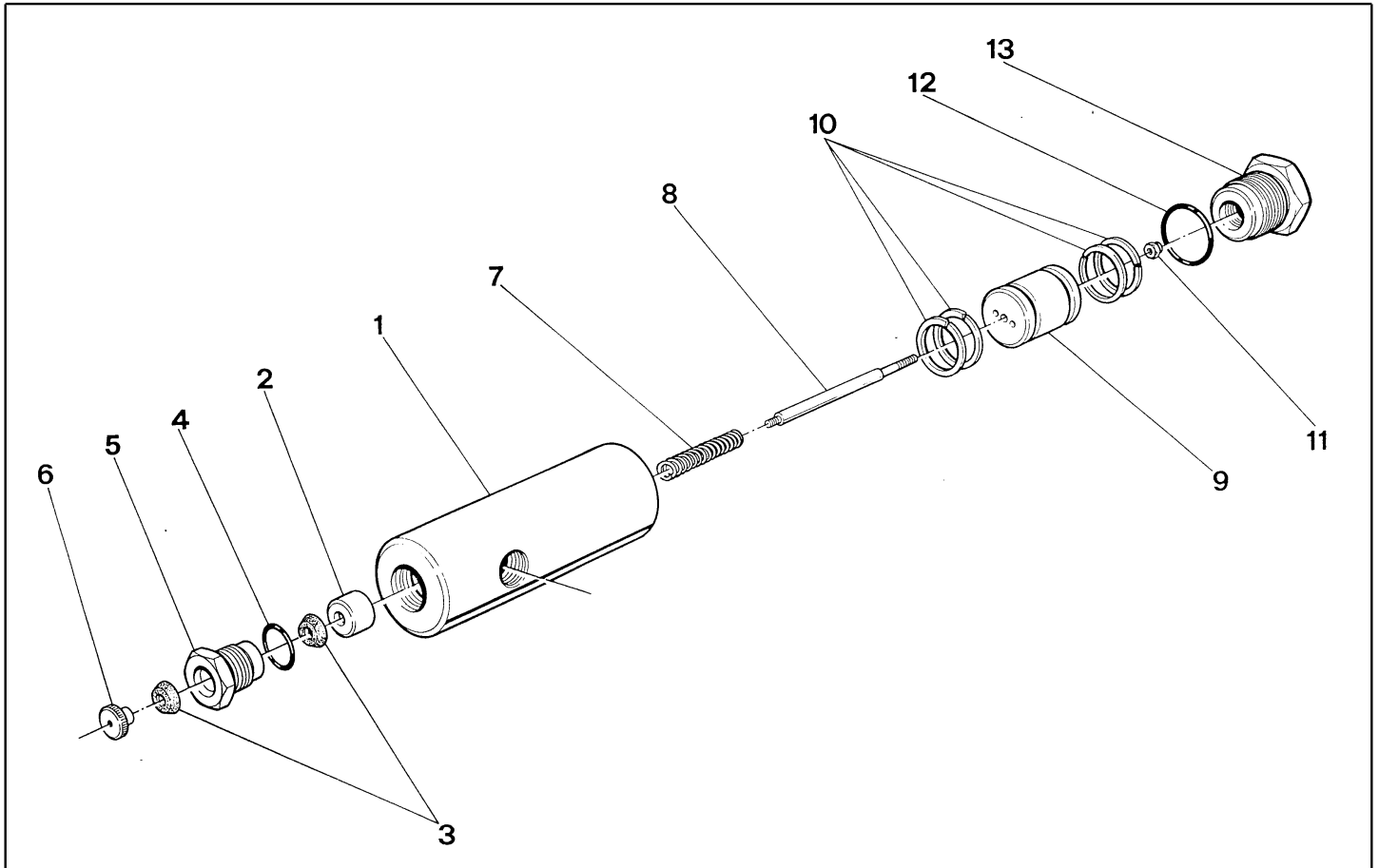

Ref. K	Part n.	Customer part n.	Description	Quantity	Validity		Price
					From	To	
	GUGO09720	00009720	O-RING D. 14 X 1.78 NBR 70SH	1,00			--
	LAFN12871	00012871	EXTENSION SF/B HONDA	1,00			--
0001	RCDS08187	00008187	BODY	1,00			--
0002	RCDS08188	00008188	SPRING GUIDE	1,00			--
0003	GUGO08189	00008189	GASKET GACO U037018	2,00			--
0004	GUGO08190	00008190	O-RING	1,00			--
0005	RCDS08191	00008191	CAP M 16X1,5	1,00			--
0006	PVVR12870	00012870	PAWL M 4 G400	1,00			--
0007	MLML08186	00008186	SPRING D.1-7,3 L31,5	1,00			--
0008	PVVR12869	00012869	ROD M 4.5 G400	1,00			--
0009	RCDS08184	00008184	SMALL PISTON	1,00			--
0010	PVVR08183	00008183	SPLIT RING D.22-18X1,5	4,00			--
0011	VTDD09556	00009556	NUT M3 TEFLON	1,00			--
0012	GUGO08182	00008182	O-RING D. 21.91 X 1.78 NBR 70SH	1,00			--
0013	PVVR08181	00008181	CAP M 24X1	1,00			--